



Office Furniture Catalogue: Storage

Volume 18 2022/2023

WWW.FHG.COM.AU

Call us to discuss your office furniture project:

07 3808 7922



INFINITY SWING DOOR CUPBOARDS

Dimensions :

Options	<ul style="list-style-type: none"> IFSD96 - 2 Door - 900 x 600mm IFSD1245 - 3 Door - 1200 x 450mm IFSD1545 - 3 Door - 1500 x 450mm IFSD1845 - 4 Door - 1800 x 450mm
Height	730mm

Finish Options :

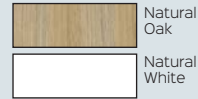

Features :

- Lockable - 2 keys supplied
- Shark nose feature on tops of doors
- Black edging feature
- Adjustable levelling feet & Soft close hinges
- 18mm Thick E0 rated melamine board

Certifications :



INFINITY BOOKCASES

Dimensions :

Options	<ul style="list-style-type: none"> IFBK12 - 1200mm Height IFBK18 - 1800mm Height
Width	900mm
Depth	315mm

Finish Options :



Features :

- Adjustable shelves
- Black edging feature
- Aluminium tapered legs
- 25mm Thick Shelves, 18mm Sides
- E0 rated melamine board

Certifications :



ETERNITY MEETING TABLE

Dimensions :

Round	<ul style="list-style-type: none"> D-ERT9 - 900mm Dia. D-ERT12 - 1200mm Dia.
Square	D-ERT990 - 900W x 900D
Height	730mm

Top Finish :

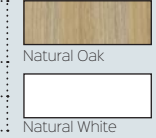

Base Finish :

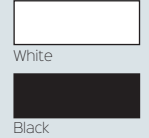

Features :

- Powdercoat base
- 25mm thick E0 Melamine top
- 2mm gauge steel construction
- Matches Eternity range

Certifications :



CLAMP MOUNT SHELF - CMSHELF600

Dimensions :

Width	600mm
Depth	270mm
Height	475mm

Finish Options :

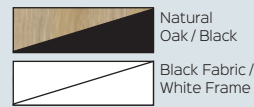

Features :

- 25mm thick E0 rated enviroboard
- Comes with 4 x wire dividers
- Convenient shelf above desk top
- Clamps onto desk top

Certifications :



INFINITY DESK MOUNTED SHELF - DMSHELF

Dimensions :

Width	600mm
Depth	300mm
Overall Height	450mm
Desk Top to Shelf Height	208mm

Finish Options :

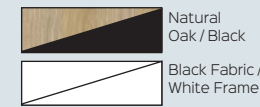

Features :

- 25mm thick E0 rated enviroboard
- Comes with 4 x wire dividers

Certifications :



INFINITY SCREEN HUNG SHELF - ISHELF600

Dimensions :

Width	600mm
Depth	270mm
Height	250mm

Finish Options :

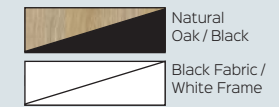

Features :

- 18mm thick E0 rated enviroboard
- Powdercoated steel shelf brackets
- Available in 2 finishes
- Hangs from infinity centre screens

Certifications :



RAPID SPAN STORAGE

RAPID SPAN CUPBOARD - SP2FD18

Specifications :

Width	900mm
Depth	450mm
Height	1800mm

Features :

- Includes 1 x fixed mid shelf
- 3 x adjustable shelves
- Soft close hinges
- Fully lockable with 2 keys included
- E0 Melamine board

Finish Options :



Certifications :



RAPID SPAN BOOKCASE

Specifications :

Width	900mm
Depth	315mm
Height	• SPBC12 - 1200mm
Options	• SPBC18 - 1800mm

Features :

- E0 Melamine board
- 1200mm H comes with 3 x adjustable shelves, 1800mm H comes with 4 x adjustable shelves.

Finish Options :

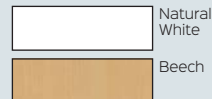

Certifications :



RAPID SPAN CREDENZA

Specifications :

Width	• SPC12 - 1200mm
Options	• SPC18 - 1800mm
Depth	450mm
Height	730mm

Features :

- Sliding door credenza
- Includes 2 x adjustable shelves
- Fully lockable with 2 keys included
- E0 Melamine board

Finish Options :



Certifications :



UNDER DESK STORAGE - SPMP3

Specifications :

Width	447mm
Depth	465mm
Height	690mm
Weight Rating	30kg per Drawer

Features :

- Melamine mobile pedestal on castors
- 2 x personal drawers and 1 x file drawer
- Lockable with key, 2 keys supplied
- E0 Melamine board

Top Finishes :

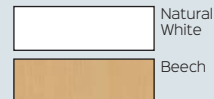

Certifications :



RAPID SPAN HUTCH

Specifications :

Width	• SPH12 - 1200W - 2 Vertical sections
Options	• SPH18 - 1800W - 3 vertical sections
Depth	315mm
Height	1070mm

Features :

- Includes adjustable shelves
- Sits on top of credenza
- Provides extra storage space
- E0 Melamine board

Finish Options :



Certifications :



RAPID WORKER CORNER WORKSTATION

Specifications :

Desk Size Options	• RWCWS1212 - 1200 x 1200mm	• RWCWS1215 - 1200 x 1500mm
	• RWCWS1218 - 1200 x 1800mm	• RWCWS1221 - 1200 x 2100mm
	• RWCWS1515 - 1500 x 1500mm	• RWCWS1815 - 1800 x 1500mm
	• RWCWS1818 - 1800 x 1800mm	• RWCWS2115 - 2100 x 1500mm
	• RWCWS2118 - 2100 x 1800mm	• RWCWS2121 - 2100 x 2100mm
Height	730mm	
Depth	600mm (or 750mm in 1800 x 1800mm* In Beech and Cherry only)	

Finish Options :

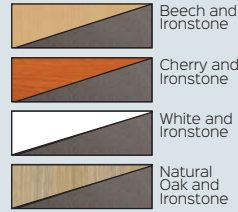

Features :

- 3-piece corner workstation
- Huge range of sizes to suit your space
- Cable entry hole in corner piece
- Modesty panels with space for cable access

Certifications :



RAPID WORKER FIXED PEDESTAL

Options :

CDKP1D1F	1 Drawer and 1 File Drawer 465W x 447D x 454H
CDKP3D	3 Drawers 465W x 447D x 454H
CRP3D	3 Drawers (For Return) *In Ironstone only 465W x 370D x 454H

Finish Options :

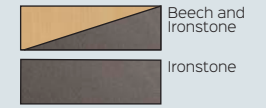

Features :

- Install on Right or Left side of Desk
- EO Melamine board
- Lockable, 2 keys supplied

Certifications :



*Beech / Ironstone
1500 x 1500mm



*Cherry / Ironstone
1800 x 1800mm



*Natural Oak / Ironstone
1800 x 1800mm

NEW



NEW



*CRP3D Return Fixed Pedestal
Pictured on a Natural White Return

NEW

CUPBOARD - CSC2FD

Specifications :

Width	900mm
Depth	450mm
Height	1800mm

Finish Options :

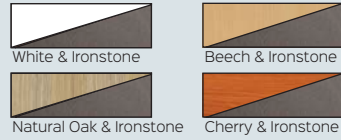

Features :

- 3 x adjustable shelves
- 1 x fixed middle shelf
- Fully lockable with 2 keys included

Certifications :



BOOKCASE

Specifications :

Height	• CBC9 - 900mm
	• CBC12 - 1200mm
	• CBC18 - 1800mm
Width	900mm
Depth	315mm

Finish Options :



Features :

- 3 x adjustable shelves in 900 and 1200 H
- 4 x adjustable shelves in 1800 H

Certifications :



LOCKABLE WALL UNIT - CSC2HD

Specifications :

Width	900mm
Depth	450mm
Height	1800mm

Finish Options :

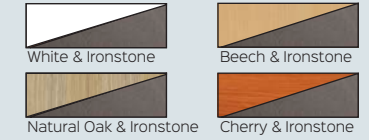

Features :

- Lockable half height storage
- 2 adjustable shelves
- Supplied with 2 keys

Certifications :



FILING CABINET

Specifications :

Width	465mm
Depth	600mm
Height	• C3FC - 998mm
	• C4FC - 1300mm

Finish Options :



Features :

- Melamine 3 or 4 drawer filing cabinet
- Lockable, supplied with 2 keys
- Metal runner arms

Certifications :



PIGEON HOLE UNIT - PH20

Specifications :

Width	1040mm
Depth	380mm
Height	1040mm

Finish Options :



Features :

- Melamine pigeon hole unit
- 20 slots
- Adjustable shelves

Certifications :



EXTRA SHELVES

Specifications :

CBC SHELF	• 890W x 420D x 25T
	• Use with Bookcases
FD SHELF	• 858W x 405D x 18T
	• Use with Cupboards

Finish Options :

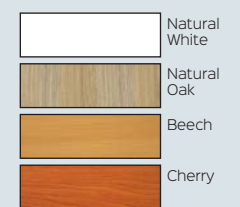

Certifications :



CREDENZA

Specifications :

Width	<ul style="list-style-type: none"> • CMZ1245 - 1200mm • CMZ1545 - 1500mm • CMZ1845 - 1800mm
Depth	450mm
Height	730mm

Features :

- E0 Melamine board
- 2 x adjustable shelves
- Fully lockable sliding door with 2 keys

Certifications :



Finish Options :

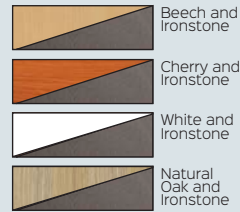

RAPID WORKER HUTCH

Specifications :

Width	<ul style="list-style-type: none"> • CH12 - 1200mm • CH15 - 1500mm • CH18 - 1800mm
Depth	315mm
Height	1070mm

Features :

- 4 shelves in 1200mm and 1500mm sizes
- 6 shelves in 1800mm size
- E0 Melamine board

Certifications :



Finish Options :

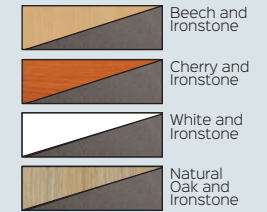

RAPID WORKER MOBILE PEDESTAL

Specifications :

CMP2F	2 Drawers
CMP2D1F	2 Drawers and 1 File Drawer
CMP4D	4 Drawers
Size	447mm x 465mm x 690mm

Features :

- Drawers with metal runners
- Key locking - 2 keys supplied

Certifications :



Finish Options :



RAPID WORKER DESK HOB

Specifications :

CHOB15N	• 1500W x 350D
CHOB18N	• 1800W x 350D
Height	400mm

Features :

- Creates a reception counter or privacy for your straight or corner desk

Certifications :



Finish Options :

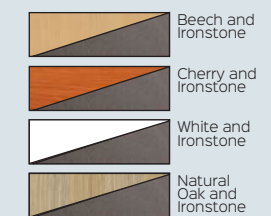

RAPID VIBE LAPTOP DESK - CDK96

Specifications :

Width	900mm
Depth	600mm
Height	730mm

Finish Options :

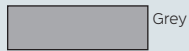

Certifications :



Features :

- E0 Melamine open desk
- Compact size for laptop or hot desk
- Matching under desk modesty panel



RAPID VIBE OPEN DESK

Specifications :

Top Size	• CDK126 - 1200W x 600D
Options	• CDK1575 - 1500W x 750D
	• CDK189 - 1800W x 900D
Height	730mm

Finish Options :

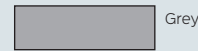

Certifications :



Features :

- E0 Melamine open desk
- Matching under desk modesty panel
- Use with Desk Return for more workspace and to create a corner workstation



RAPID VIBE DESK RETURN - CR6

Specifications :

Width	900mm
Depth	600mm
Height	730mm

Finish Options :

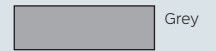

Certifications :



Features :

- E0 Melamine return
- Fix to any straight desk
- Create a corner shaped workstation
- Extra desk top space



RAPID VIBE PEDESTALS

Specifications :

CDKP3D Fixed Pedestal	465W x 447D x 454H 3 Drawers
SPMP3 Mobile Pedestal	447W x 465D x 690H 2 Drawers and 1 File

Finish Options :

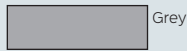

Certifications :



Features :

- Lockable with 2 keys supplied
- Metal runners
- Fifth wheel for stability in Mobile Pedestal
- Silver handles
- E0 Melamine board



RAPID VIBE CORNER WORKSTATION - CWS1818

Specifications :

Overall Width	1800mm x 1800mm
Top Depth	600mm
Height	730mm

Finish Options :

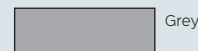

Certifications :



Features :

- E0 Melamine board
- 3 Piece corner workstation
- Under desk modesty panels
- 1 x 80mm cable entry hole in corner



RAPID VIBE DESK HOB - CHOB18N

Specifications :

Width	1800mm
Depth	350mm
Height	400mm

Finish Options :

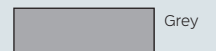

Certifications :



Features :

- Straight edge hob
- Use on straight or corner desk
- Creates a reception counter
- Add privacy to a desk
- E0 Melamine board



RAPID VIBE CUPBOARD - SP2FD18

Specifications :

Width	900mm
Depth	450mm
Height	1800mm

Features :

- Full door cupboard
- 1 x fixed mid shelf
- 3 x adjustable shelves
- Fully lockable with 2 keys included
- E0 Melamine board

Finish Options :

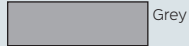

Certifications :



RAPID VIBE BOOKCASE

Specifications :

Width	900mm
Depth	315mm
Height	• SPBC12 - 1200mm • SPBC18 - 1800mm

Features :

- Open bookcase
- 1200mm H with 3 x adjustable shelves
- 1800mm H with 4 x adjustable shelves
- E0 Melamine board

Finish Options :

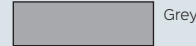

Certifications :



RAPID VIBE HUTCH

Specifications :

Width	• SPH12 - 1200mm • SPH18 - 1800mm
Depth	315mm
Height	1070mm

Features :

- Includes adjustable shelves
- 1200mm W with 2 vertical sections
- 1800mm W with 3 vertical sections
- E0 Melamine board

Finish Options :

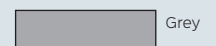

Certifications :



RAPID VIBE CREDENZA

Specifications :

Width	• SPC12 - 1200mm • SPC18 - 1800mm
Depth	450mm
Height	730mm

Features :

- Sliding door credenza
- 2 x adjustable shelves
- Fully lockable with 2 keys included
- E0 Melamine board

Finish Options :

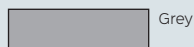

Certifications :



BREAKOUT CHAIRS & STOOLS, CUSHIONS

TAURUS CHAIR - TAURUS

Specifications :

Overall Size	735H x 540W x 460D
Seat Size	440H x 440W x 435D
Weight Rating	110kg

Finish Options :



Black / Chrome

Features :

- Chrome frame and legs
- Wrap around polypropylene shell
- Cut out feature on back
- Stackable

Certifications :



VIRGO BAR STOOL - VIRGO ST

Specifications :

Overall Size	820H x 475W x 475D
Seat Size	770H x 440W x 450D
Weight Rating	110kg

Finish Options :



Black / Timber



Grey / Timber



Green / Timber

Features :

- Modern bar stool
- Oak coloured frame
- Curved polypropylene plastic seat pan



CAD Cushion

Specifications :

Overall Width	460mm
Overall Depth	460mm
Overall Height	40mm
Overall height of Caddy with cushion	610mm

Finish Options :



- Choose from any fabric in any of our partnered ranges on page 69

Features :

- Fabric seat Cushion. *Caddy not included



TAURUS BAR STOOL - TAURUS STOOL

Specifications :

Overall Size	1050H x 525W x 460D
Seat Size	750H x 435W x 455D
Weight Rating	110kg

Finish Options :



Black / Chrome

Features :

- Chrome frame and legs
- Wrap around polypropylene shell
- Cut out feature on back
- Leg rest on chrome base / frame

Certifications :



ARIES BAR STOOL - ARIES ST

Specifications :

Overall Size	853H x 455W x 545D
Seat Size	760H x 440W x 450D
Weight Rating	110kg

Finish Options :



Black / Black



Grey / Black



Green / Black

Features :

- Stylish black metal curved frame
- Polypropylene plastic seat pan
- Leg rest on base / frame



GMP3 Cushion

Specifications :

Overall Width	460mm
Overall Depth	475mm
Overall Thickness	40mm
Overall height of GMP3 with cushion	660mm

Finish Options :

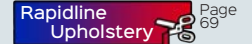

- Choose from any fabric in any of our partnered ranges on page 69

Features :

- Fabric seat Cushion. *Mobile Ped not included



PERSONAL STORAGE

GO STEEL MOBILE PEDESTAL - GMP3

Specifications :

Overall Width	460mm
Overall Depth	472mm
Overall Height	610mm
Top Drawer Size	390W x 475D x 65H
Filing Drawer Size	390W x 475D x 250H
Weight Rating	30kgs per Drawer

Finishes :

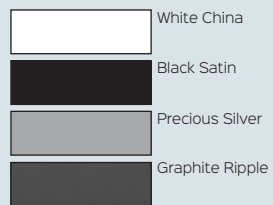

Features :

- For larger workstations
- Lockable - Supplied with 2 keys
- Stores foolscap files back to front
- Flush drawer front
- Full extension ball bearing runners
- Fifth wheel for stability
- Keyed alike locks available for extra

Certifications :



GO STEEL SLIMLINE MOBILE PED - GSP3

Specifications :

Overall Width	300mm
Overall Depth	472mm
Overall Height	610mm
Top Drawer Size	230W x 460D x 65H
Filing Drawer Size	230W x 460D x 250H
Weight Rating	30kgs per Drawer

Finishes :

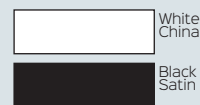

Features :

- Slimline for smaller workstations
- Lockable - Supplied with 2 keys
- Stores foolscap files side to side
- Flush drawer front
- Ball bearing runners
- Fifth wheel for stability
- Keyed alike locks available for extra

Certifications :



ETERNITY SLIMLINE MOBILE PED - EMP3 WB

Specifications :

Overall Width	300mm
Overall Depth	535mm
Overall Height	580mm
Top Drawer Size	240W x 500D x 70H
Filing Drawer Size	240W x 500D x 250H
Weight Rating	30kgs per Drawer

Finishes :



Features :

- Stylish curved corners
- Slimline for smaller workstations
- Powdercoated steel mobile pedestal
- 2 personal drawers and 1 file drawer
- Fifth wheel for stability and anti-tilt
- Lockable - Supplied with 2 keys

Certifications :



*Black Satin

*Graphite Ripple



*White China



*White China

*Precious Silver



*Black Satin



GO STEEL MOBILE CADDY - GCADN

Specifications :

Overall Size	618H x 1050W x 500D
Tambour (internal)	500H x 560W x 470D
Top 2 drawers (internal size)	70H x 320W x 460D
Bottom filing drawer (internal)	240H x 320W x 460D

Finishes :

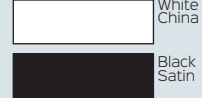

Certifications :



Features :

- On castors, with 5th Wheel On File Drawer
- Lockable pedestal and tambour door with 2 keys supplied
- 2 drawers and 1 file drawer, files run front to back
- Tambour section with adjustable shelf
- GCADN-L - Tambour door on left hand side
- GCADN-R - Tambour door on right hand side
- Seat pad available for additional extra

GO STEEL FILING CABINET

Specifications :

Width	460mm
Depth	620mm
Drawer Options	<ul style="list-style-type: none"> • GFCA2 - 2 drawer, 705mm H • GFCA3 - 3 drawer - 1016mm H • GFCA4 - 4 drawer - 1321mm H

Finishes :

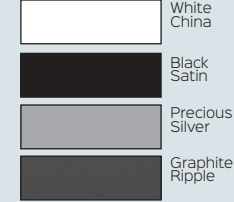

Certifications :



Features :

- Lockable - Supplied with 2 keys
- Heavy duty and Fully riveted
- Ball bearing runners
- 40kg weight capacity per drawer

GO STEEL LATERAL FILING CABINET

Specifications :

Width	900mm
Depth	473mm
Height	<ul style="list-style-type: none"> • GLF2 - 2 drawer - 705mm • GLF3 - 3 drawer - 1016mm • GLF4 - 4 drawer - 1321mm

Finishes :



Certifications :



Features :

- Lockable - Supplied with 2 keys
- Riveted construction for extra strength
- Heavy duty and Anti-tilt
- 2 rows of folders per drawer



*Graphite Ripple



*Silver Grey



*Black Ripple



*White China



900mm Wide TAMBOUR DOOR CUPBOARD

Specifications :

Height Options	<ul style="list-style-type: none"> GTD109 - 1016mm GTD129 - 1200mm GTD199 - 1981mm
Depth	473mm
Width	900mm

Features :

- Easy glide track
- Magnetic anti slam rail keeps doors closed
- Fully riveted for extra strength
- 40kg weight rating per shelf
- Fully Lockable with 2 keys supplies (master series)
- Adjustable feet for leveling
- Tambour door cupboard unit only, shelves sold separately
- Optional extra shelves and range of accessories available

Finishes :

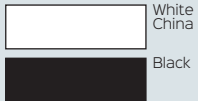

Certifications :



1200mm Wide TAMBOUR DOOR CUPBOARD

Specifications :

Height Options	<ul style="list-style-type: none"> GTD1012 - 1016mm GTD1212 - 1200mm GTD1912 - 1981mm
Depth	473mm
Width	1200mm

Features :

- Easy glide track
- Magnetic anti slam rail keeps doors closed
- Fully riveted for extra strength
- 40kg weight rating per shelf
- Fully Lockable with 2 keys supplies (master series)
- Adjustable feet for leveling
- Tambour door cupboard unit only, shelves sold separately
- Optional extra shelves and range of accessories available

Finishes :

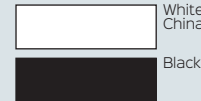

Certifications :



Pictured Left : GTD199 WC
White China, 1981mm H x 900mm W

Top shelf is a Slotted shelf with dividers
Middle shelf is a standard plain shelf
Bottom shelf is a Pull out filing frame
**Standard tambour does not come with add-on shelving and accessories

Pictured Below: GTD129 BL
Black, 1200H x 900W

**Standard tambour does not come with add-on shelves



Pictured Left : GTD1912 WC
White China, 1981mm H x 1200mm W

Pictured bottom shelf is a Pull out filing frame
**Standard tambour does not come with add-on shelving and accessories

Pictured Below: GTD1012 WC
White, 1016mm H x 1200mm W

**Standard tambour does not come with add-on shelves



PLANTER BOX

Specifications :

Width	• PB900 - Suits 900mm W unit
Options	• PB1200 - Suits 1200mm W unit
Size	230mm H x 473mm D

Finishes :

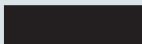
	White China
	Black

Features :

- Space for 3 x 200mm plant pots (**plants and pots not included**)
- Incorporated drip tray
- Use on top of tambour door cupboards or lateral filing cabinets

Certifications :





PLAIN SHELF

Specifications :

Width	• GTD900 - Suits 900mm W unit
Options	• GTD1200 - Suits 1200mm W unit
Size	470mm D x 30mm T

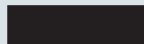
Finishes :

	White China
	Black

Features :

- Standard shelf to use with Tambour door cupboards
- Easy to install - Clips supplied
- Easy to adjust to different heights

Certifications :

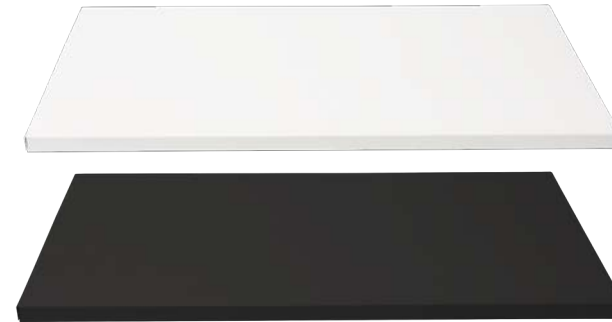



PULL OUT SHELF

Specifications :

Width	GG09PS - Suits 900mm W unit
Options	GG12PS - Suits 1200mm W unit
Size	470mm D x 30mm T

Finishes :

	White China
---	-------------

Features :

- Pull out shelf for use in tambour door cupboard units
- Shelf slides out for easy operation to find or work on files

Certifications :



ROLL OUT FILING FRAME

Specifications :

Width	• GG09FF - 750mm width for 900mm wide unit - can take 1 row of foolscap folders
Options	• GG12FF - 1050mm width for 1200mm wide unit - can take 2 rows of foolscap folders

Features :

- Store foolscap folders and roll out for easy access to files

Finishes :

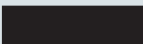
	White China
	Black

Certifications :





SLOTTED SHELF AND DIVIDERS

Specifications :

Shelf Options	• GG09SLOT - Suits 900mm W unit
	• GG12SLOT - Suits 1200mm W unit
Dividers	GS7D - pack of 5 slotted shelf dividers

Finishes :

	White China
	Black

Certifications :



Features :

- Slotted shelf for use in tambour door cupboards
- Accepts separate slotted shelf dividers
- Rear support for dividers
- Reinforced shelf for heavy duty durability and stability
- Great for dividing documents and folders
- Holds folders vertically



SHELVING UNIT - GSC9422

Specifications :

Overall Width	910mm
Overall Depth	400mm
Overall Height	2200mm

Features :

- Flat packed
- Clip together easy to assemble
- Includes 5 adjustable shelves
- In silver grey finish only
- 40kg weight rating per shelf

Finishes :

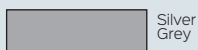

Silver Grey

Certifications :



GO STEEL WARDROBE - GWA18

Specifications :

Overall Width	910mm
Overall Depth	450mm
Overall Height	1830mm

Features :

- Lockable GO steel swing door wardrobe
- Hanging rail and 3 shelves
- 4 separate storage compartments
- Fully lockable
- Supplied with 2 keys

Finishes :

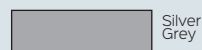

Silver Grey

Certifications :

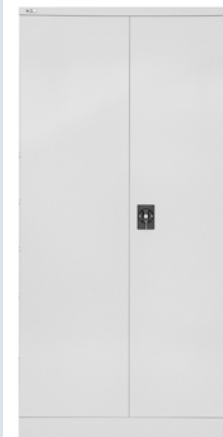

OFFICE LOCKER - OFL138N WC

Specifications :

Overall Width	800mm
Overall Depth	486mm
Overall Height	1375mm

Features :

- Space efficient storage system for offices
- 6 lockable individual compartments per unit
- Removable shelf per locker
- Mail slot on each door
- Name holder fitted to each door
- 4 easy adjustable levelling feet
- Unit finished in powdercoat
- Combination locking system with private and public functions available

Finishes :



White China

Certifications :



NEW

GO STEEL CUPBOARD

Specifications :

Size	910mm W x 450mm D
Height	• GCA10 - 2 shelves - 1015mm
Options	• GCA18 - 3 shelves - 1830mm
	• GCA20 - 4 shelves - 2000mm

Features :

- GO steel flush lock cupboard
- Supplied with 2 keys
- GCWSG Shelf and coat rail as optional extra for use in cupboard

Finishes :

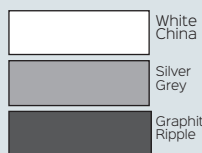

White China

Silver Grey

Graphite Ripple

Certifications :



*Graphite Ripple



*White China

MELAMINE LOCKERS

Melamine lockers offer a personal storage solution that blends into your space. Use in both office and educational applications. Each locker includes 2 x keys per lock.

Various internal features in each compartment. Moisture resistant melamine and MDF doors with soft close hinges, and adjustable levelling feet to each unit.

Certifications :



STEP DOOR - SDWRML380/2

Specifications :

Overall Height	1850mm
Overall Width	380mm
Overall Depth	455mm

Features :

- MR Melamine carcass
- MDF doors
- Soft close hinges
- Adjustable leveling feet
- 1 x hanging rail per compartment
- Includes 2 x keys per lock
- Digital Lock option for extra

Finish Options :



SINGLE LOCKER - WRML-305/1

Specifications :

Overall Height	1850mm
Overall Width	305mm
Overall Depth	455mm

Features :

- MR Melamine carcass
- MDF doors
- Soft close hinges
- Adjustable leveling feet
- 1 x hanging rail
- 1 x hat shelf
- Includes 2 x keys per lock
- Digital Lock option for extra

Finish Options :



Melamine lockers offer a personal storage solution that blends into your space. Use in both office and educational applications. Each locker includes 2 x keys per lock.

Various internal features in each compartment. Moisture resistant melamine and MDF doors with soft close hinges, and adjustable levelling feet to each unit.

Finish Options :



Certifications :



2 DOOR LOCKER - WRML-305/2

Specifications :
Overall Size 1850H x 305W x 455D

Features :

- MR Melamine carcass
- MDF doors
- Soft close hinges
- Adjustable leveling feet
- 1 x hanging rail per compartment
- Includes 2 x keys per lock
- Digital Lock option for extra

3 DOOR LOCKER - WRML-305/3

Specifications :
Overall Size 1850H x 305W x 455D

Features :

- MR Melamine carcass
- MDF doors
- Soft close hinges
- Adjustable leveling feet
- 3 x Locker compartments
- Includes 2 x keys per locker
- Digital Lock option for extra

4 DOOR LOCKER - WRML-305/4

Specifications :
Overall Size 1850H x 305W x 455D

Features :

- MR Melamine carcass
- MDF doors
- Soft close hinges
- Adjustable leveling feet
- 4 x Locker compartments
- Includes 2 x keys per locker
- Digital Lock option for extra

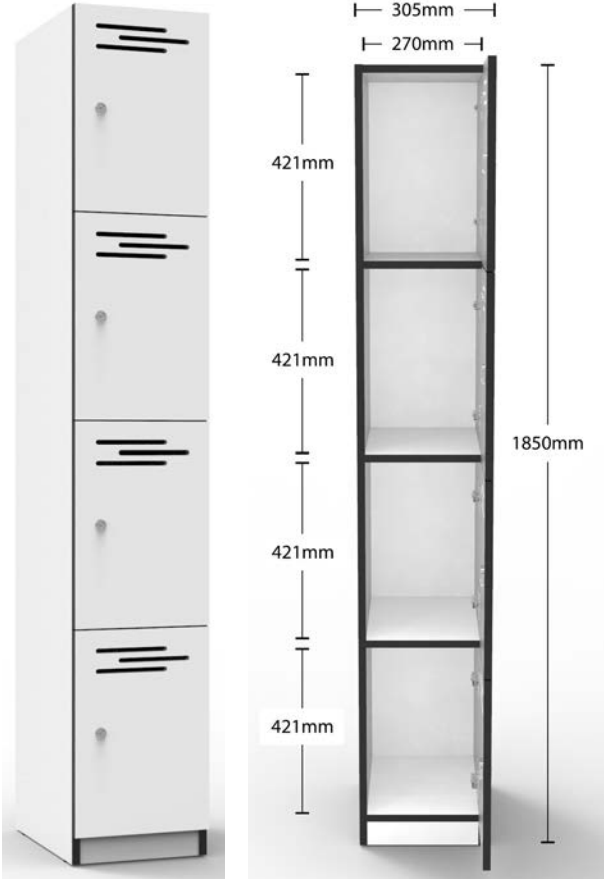
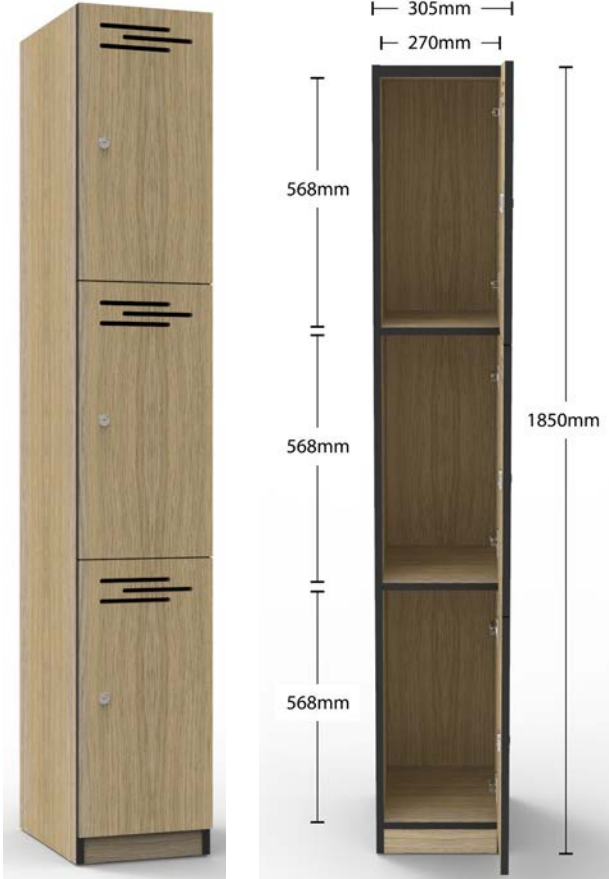
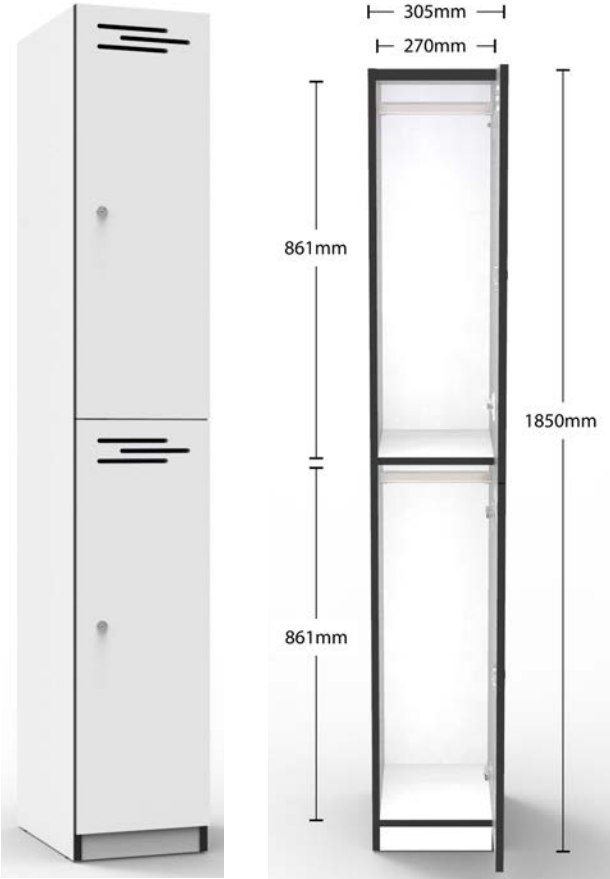

STEEL LOCKERS

Steel lockers offer an easy way to store personal belongings. Includes 2 keys supplied per locker compartment. Choose from single, 2 or 4 door options to suit your requirements, or a step locker which provides 2 hanging spaces.

Finish Options :

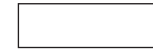

White China
(305W units only)



Silver Grey
(305W & 380W units)



SINGLE DOOR LOCKER	2 DOOR LOCKER	4 DOOR LOCKER	STEP LOCKER - GSL380														
<p>Specifications :</p> <table border="1"> <tr> <td>Width Options</td> <td>• GL305/1 - 305mm • GL380/1 - 380mm</td> </tr> <tr> <td>Size</td> <td>1830mm H x 455mm D</td> </tr> </table> <p>Features :</p> <ul style="list-style-type: none"> • Riveted construction for extra strength • Vented doors for ventilation • 1 x hat shelf, 1 x coat rail storage • Full length stiffeners fitted to each door for rigidity 	Width Options	• GL305/1 - 305mm • GL380/1 - 380mm	Size	1830mm H x 455mm D	<p>Specifications :</p> <table border="1"> <tr> <td>Width Options</td> <td>• GL305/2 - 305mm • GL380/2 - 380mm</td> </tr> <tr> <td>Size</td> <td>1830mm H x 455mm D</td> </tr> </table> <p>Features :</p> <ul style="list-style-type: none"> • Riveted construction for extra strength • Vented doors for ventilation • 1 x coat hook per compartment • Full length stiffeners fitted to each door for rigidity 	Width Options	• GL305/2 - 305mm • GL380/2 - 380mm	Size	1830mm H x 455mm D	<p>Specifications :</p> <table border="1"> <tr> <td>Width Options</td> <td>• GL305/4 - 305mm • GL380/4 - 380mm</td> </tr> <tr> <td>Size</td> <td>1830mm H x 455mm D</td> </tr> </table> <p>Features :</p> <ul style="list-style-type: none"> • Riveted construction for extra strength • Vented doors for ventilation • Full length stiffeners fitted to each door for rigidity 	Width Options	• GL305/4 - 305mm • GL380/4 - 380mm	Size	1830mm H x 455mm D	<p>Specifications :</p> <table border="1"> <tr> <td>Overall Size</td> <td>1830H x 380W x 455D</td> </tr> </table> <p>Features :</p> <ul style="list-style-type: none"> • Riveted construction for extra strength • Vented doors for ventilation • 1 x hanging rail per compartment • Full length stiffeners fitted to each door for rigidity • *Silver Grey finish only 	Overall Size	1830H x 380W x 455D
Width Options	• GL305/1 - 305mm • GL380/1 - 380mm																
Size	1830mm H x 455mm D																
Width Options	• GL305/2 - 305mm • GL380/2 - 380mm																
Size	1830mm H x 455mm D																
Width Options	• GL305/4 - 305mm • GL380/4 - 380mm																
Size	1830mm H x 455mm D																
Overall Size	1830H x 380W x 455D																



LOCKER STAND

Specifications :

Width Options	• SB2305 - 610mm W for 2 lockers • SB3305 - 915mm W for 3 lockers
Size	455mm D x 150mm H

Finishes :

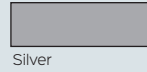

Silver

Features :

- Locker stand to bank 2 or 3 lockers
- Suitable for 305mm wide lockers only
- Silver powdercoated frame and black levelling feet
- Raise lockers off floor to allow for easy cleaning underneath and extra stability when joined together



SEAT AND STAND

Specifications :

Width Options	• S+S2305 - 610mm W for 2 lockers • S+S3305 - 915mm W for 3 lockers
Size	700mm D x 350mm H

Finishes :



Timber / Silver

Features :

- Seat and stand to suit bank of 2 or 3 lockers
- Suitable for 305mm wide lockers
- Powdercoated frame and oak style seat
- Raise lockers off floor and add a bench seat in front for use in locker rooms, schools, gyms and other applications



BENCH SEAT - BS1000

Specifications :

Overall Size	400H x 1000W x 360D
--------------	---------------------

Finishes :



Timber / Silver

Features :

- Single sided bench seat
- Light oak style wood slats
- Silver coated frame
- Black levelling feet



SLOPING TOP

Specifications :

Width Options	• G12830 - for single 305mm W locker • G32830 - for bank of 3 x 305mm W lockers
Height	270mm



Features :

- Sloping top in silver grey
- Use with either a single locker or bank of 3 lockers
- Suitable for 305mm wide lockers only
- Neat and easy to clean 30° degree sloping top

Finishes :

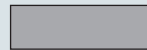

Silver



DIGITAL LOCK

Specifications :

Size	95H x 38W x 60D
Options	• DIGIPRILOCK - Private lock programming • DIGIPUBLOCK - Public lock programming



Features :

- Digital keypad code lock to be used with steel or melamine lockers as optional extra
- Public or private lock programming
- Use with both steel or melamine lockers
- *batteries not included***

Finishes :

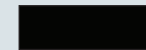

Black



BUTTERFLY LOCK - BUTTERFLY

Specifications :

Padlock Requirements	Suitable for use with padlock shafts 6mm-8mm and shackle 25mm-30mm
----------------------	--



Features :

- Butterfly lock for use with all GO Steel lockers to enable padlock facility on doors (padlock not included)
- Supplied fitted to lockers when ordered simultaneously

Finishes :



Chrome



WORKSTATIONS - FURNITURE - SEATING - STORAGE - ACCESSORIES



FHG